

LED DIMMER PRODUCT SERIES DATASHEET



High Voltage LED Dimmer



88Light High Voltage LED Dimmer have been widely applied in household lighting, business center, supermarket, office, hospital, chain operation store, restaurant, hotel, interior decoration, wedding photography, large exhibition engineering and so on.

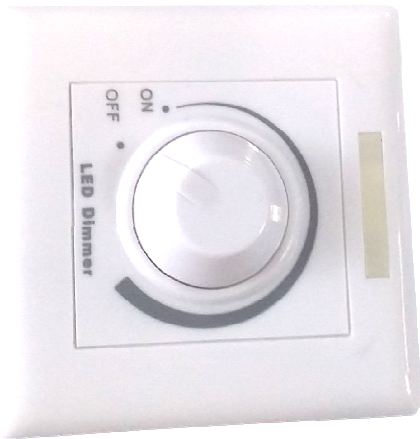

Applications:



Shopping Mall



Office



Exhibition hall



Hotel



Jewelry Store



Residence



Bank



Cafe



Living Room



Hospital

PRODUCT FEATURES

- IR remote control with MCU inside.
- Input voltage dc12/24V or ac100-240V.
- Kinds of variety of changes in effect.
- Stepless dimming or one key quick dimming.
- Delay off function.
- High temperature protection function.
- Handy installation, screw fixed.
- Environmentally friendly-fully recyclable, no mercury or other hazardous materials.
- CE & RoHS, FCC approved friendly to environment.



LED DIMMER
PRODUCT SERIES DATASHEET



PRODUCT DIAGRAM

IR Remote Controller

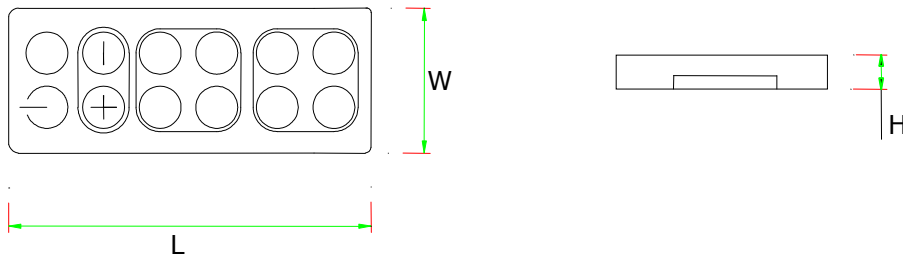

Controller

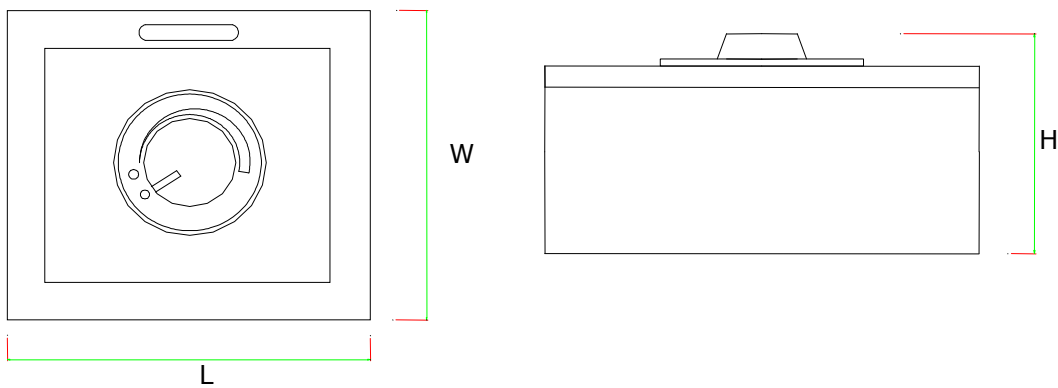

Product Name	L [mm]	W [mm]	H [mm]
12Key Remote controller	86	40	6.6
88L-DIM-T63	87	87	42
88L-DIM-T64	87	87	42
88L-DIM-T65	87	87	42

LED DIMMER
PRODUCT SERIES DATASHEET



TECHNICAL DATA

Electrical characteristics^{1, 2, 3}:

Product Name	Input Voltage [V]	Output Voltage [V]	Output ² Max Power	Continuous ³ Power	Output Current [A:max]	Remote style	IP Grade
88L-DIM-T63	DC12/24V	DC12/24V	192W	100W	8	IR	IP22
88L-DIM-T64	ac100-240	ac100-240	200W	100W	0.68	IR	IP22
88L-DIM-T65	ac100-240	ac100-240	500W	300W	2.27	IR	IP22

Note 1: Absolute ratings @ 25°C.

Note 2: The max output power is tested by input voltage 230V; it should be half when input voltage 110V, but the max output current is the same.

Note 3: Please don't use the max power as continuous power, or it will be too hot, even damage the dimmer.

Electrical characteristics ^{1, 2}:

Product Name	Matched remote controller	Effective distance [m:max]	Function	Number of Channels	Signal	Plug	Connector
88L-DIM-T63	12Key	6	Dimmer	1	SCR	Screws	Screws
88L-DIM-T64	12Key	6	Dimmer	1	SCR	Screws	Screws
88L-DIM-T65	12Key	6	Dimmer	1	SCR	Screws	Screws

Note1: Absolute ratings @ 25°C.

Note2: more functions information about the single product, please read Instructions in the products box.

PRODUCT INSTALLATION:

Installation drawing

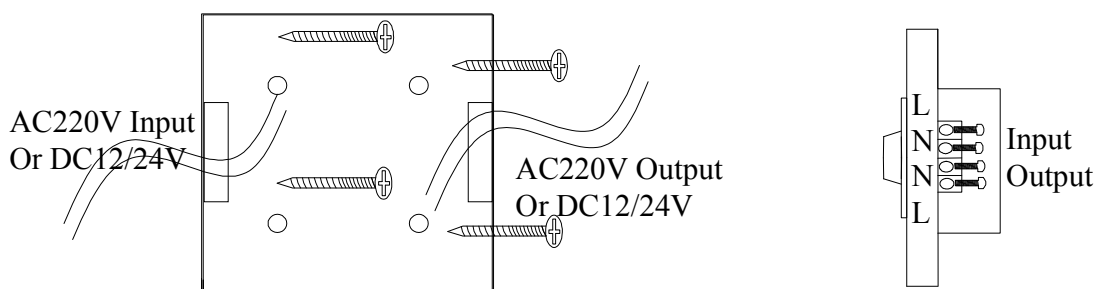

1. Fix the dimmer base with screws, then through the wires from the side holes.

2. Connect the wires to the dimmer

LED DIMMER
PRODUCT SERIES DATASHEET



PRODUCT INSTALLATION:

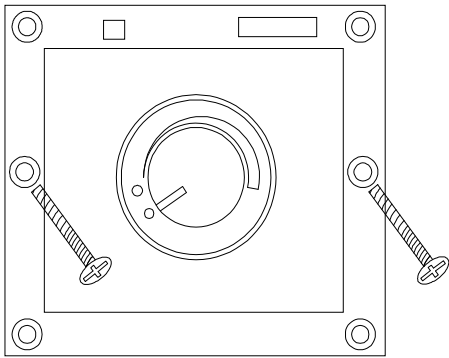

4. Fix the dimmer panel to the dimmer base with screws

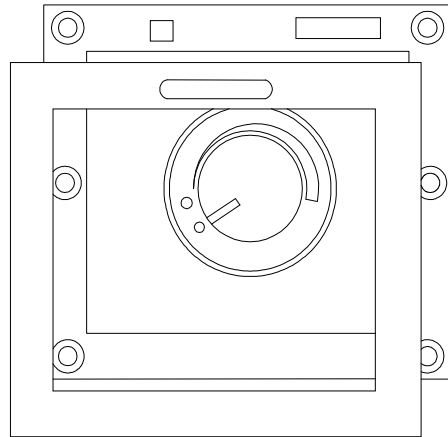

3. Cover the outer frame to the dimmer panel.

Wire Connection drawing 220V

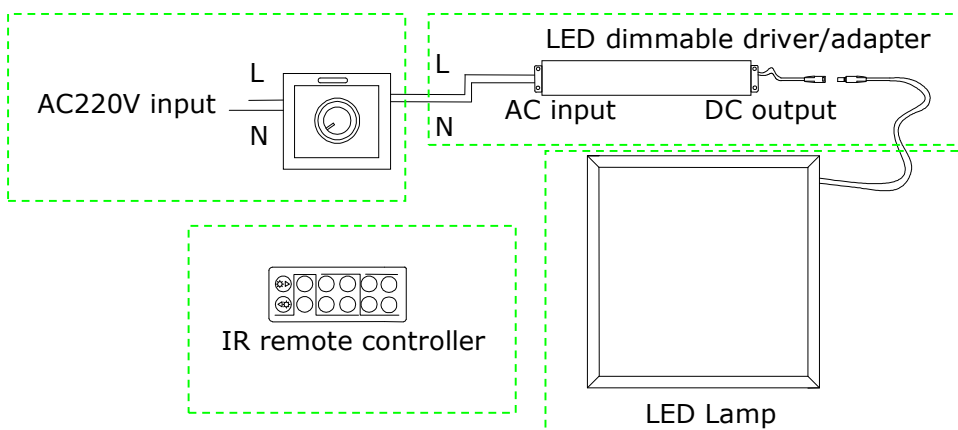

LED DIMMER
PRODUCT SERIES DATASHEET



PRODUCT INSTALLATION:

Wire Connection drawing DC24V

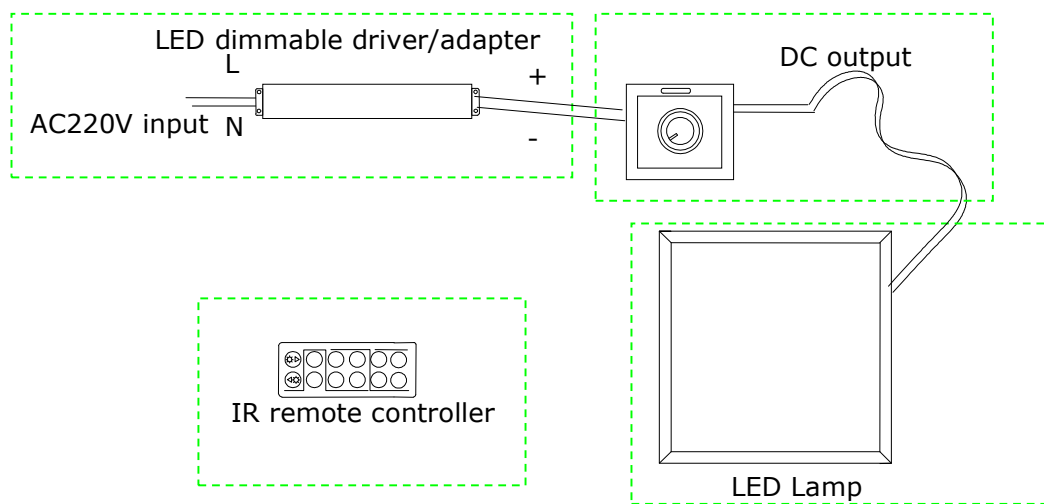

Remote Controller Instruction

1. On/Off key: Power on or Power off the lamp.
2. Delay OFF: Delay power off, after this key is pressed, the lamp will be powered off about 30 seconds later.
3. Dimming+/-: Change the brightness of the lamp, totally 256 classes dimming.
4. 25%, 50%, 75%, and 100%: Set the brightness quickly to 25%, or 50%, 75%, 100%.
5. 1,2,3,4 : DIY quick setting brightness, First, dim the lamp to the brightness needed, second, keep pressing 1 or 2, 3, 4 about 3 seconds, if the key is set successful ,the lamp will flash one time.

SAFETY

1. **Always** consult a qualified, licensed electrician prior to the installation of this product.
2. **Always** ensure that all components are joined properly before they are installed.
3. LED Dimmer is not waterproof, please don't use under water.
4. Each positive pole connected to a positive pole and each negative pole connected to a negative pole, if not, the Dimmer will not work or damaged, and the output poles can't be paralleled together, or the dimmer will be damaged.
5. Check the poles and try again.

LED DIMMER
PRODUCT SERIES DATASHEET



SAFETY

6. Each dimmer have the max current, please check the total current of the lamp before connected to the power, if the total current exceeds the maximum current, then the device will be a lot of heat, and even burned.
7. Ensure everything is connected properly before connecting to the power supply.
8. If any question about the installation, consult a competent electrical technician.

PACKING:

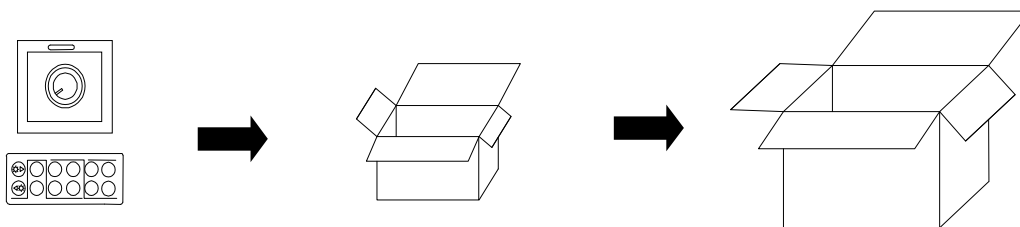

Product Name	Size of Carton (L×W×H) [mm]	Qty/Carton [pcs]	Gross Weight [Kg]	Size of box(L×W×H) [mm]	Unit Weight [g]
88L-DIM-T63	520×520×160	50	8.5	95×95×75	145
88L-DIM-T64	520×520×160	50	8.5	95×95×75	145
88L-DIM-T65	520×520×160	50	8.5	95×95×75	145

Note1: Packing for informational purposes only.

OTHER 88Light PRODUCTS:

For more information about 88Light products, or to use our online energy saving calculation software please visit our website

www.88light.com

DISCLAIMER:

88Light reserves the right to modify the design of our products as part of the company’s program of continuous improvement. 88Light cannot guarantee to match existing installed product for subsequent orders or replace the product exactly to match the product you are replacing in product appearance, color, or brightness. Specifications are subject to change without notice.